



# *M150 Flat Panel Display Touch Monitor User Guide*

3M Touch Systems, Inc.

Read and understand all safety information  
contained in this document before using this product.

The information in this document is subject to change without notice. No part of this document may be reproduced or transmitted in any form or by any means, electronic or mechanical, for any purpose, without the express written permission of 3M Touch Systems, Inc. 3M may have patents or pending patent applications, trademarks, copyrights, or other intellectual property rights covering subject matter in this document. The furnishing of this document does not give you license to these patents, trademarks, copyrights, or other intellectual property except as expressly provided in any written license agreement from 3M Touch Systems, Inc.

The information provided in this document is intended as a guide only. For the latest detailed engineering specifications, please contact your 3M Touch Systems, Inc. Application Engineer. 3M Touch Systems, Inc., Inc is committed to continually improving product designs, as a result, product specifications may be subject to change without notification.

"RoHS Directive compliant" means that the product or part does not contain any of the following substances in excess of the following maximum concentration values in any homogeneous material, unless the substance is in an application that is exempt under RoHS: (a) 0.1% (by weight) for lead, mercury, hexavalent chromium, polybrominated biphenyls or polybrominated diphenyl ethers; or (b) 0.01% (by weight) for cadmium. Unless otherwise stated by 3M in writing, this information represents 3M's knowledge and belief based on information provided by third party suppliers to 3M.

**NOTICE:** Given the variety of factors that can affect the use and performance of a 3M Touch Systems, Inc. Product (the "Product"), including that solid state equipment has operation characteristics different from electromechanical equipment, some of which factors are uniquely within User's knowledge and control, it is essential that User evaluate the 3M Touch Systems, Inc. Product and software to determine whether it is suitable for User's particular purpose and suitable for User's method of application. 3M Touch Systems, Inc. statements, engineering/technical information, and recommendations are provided for User's convenience, but their accuracy or completeness is not warranted. 3M Touch Systems, Inc. products and software are not specifically designed for use in medical devices as defined by United States federal law. 3M Touch Systems, Inc. products and software should not be used in such applications without 3M Touch Systems, Inc. express written consent. User should contact its sales representative if User's opportunity involves a medical device application.

**IMPORTANT NOTICE TO PURCHASER:** Specifications are subject to change without notice. These 3M Touch Systems, Inc. Products and software are warranted to meet their published specifications from the date of shipment and for the period stated in the specification. **3M Touch Systems, Inc. makes no additional warranties, express or implied, including but not limited to any implied warranties of merchantability or fitness for a particular purpose.** User is responsible for determining whether the 3M Touch Systems, Inc. Products and software are fit for User's particular purpose and suitable for its method of production, including intellectual property liability for User's application. If the Product, software or software media is proven not to have met 3M Touch Systems, Inc. warranty, then 3M Touch Systems, Inc. sole obligation and User's and Purchaser's **exclusive remedy**, will be, at 3M Touch Systems, Inc. option, to repair or replace that Product quantity or software media or to refund its purchase price. 3M Touch Systems, Inc. has no obligation under 3M Touch Systems, Inc. warranty for any Product, software or software media that has been modified or damaged through misuse, accident, neglect, or subsequent manufacturing operations or assemblies by anyone other than 3M Touch Systems, Inc. **3M Touch Systems, Inc. shall not be liable in any action against it in any way related to the Products or software for any loss or damages, whether non-specified direct, indirect, special, incidental or consequential (including downtime, loss of profits or goodwill) regardless of the legal theory asserted.**

© 2002--2006 3M All rights reserved.  
Printed in the United States of America.

Document Title: *M150 FPD Monitor User Guide*  
Document Number: 19-258, Version 06

MicroTouch, the MicroTouch logo, and ClearTek are either registered trademarks or trademarks of 3M in the United States and/or other countries.

Windows and/or other Microsoft products referenced herein are either registered trademarks or trademarks of Microsoft Corporation in the U.S. and/or other countries.

# Contents

## Overview

Important Safety Information .....	5
Intended Use .....	5
Explanation of Symbols .....	6
Service and Repair Indicators .....	7
3M Touch Systems Support Services .....	8
3M Touch Systems Worldwide Offices .....	8

## Chapter 1

### Introduction to Flat Panel Displays

Native Video Resolution on a Flat Panel Display .....	10
Options for Using Other Video Resolutions .....	10

## Chapter 2

### Setting Up Your M150 FPD Monitor

System Requirements .....	11
Unpacking Your Touch Monitor .....	12
Arm Mounting Option .....	12
Countertop Base Mounting Option .....	13
Access to the Video Controls .....	14
Adjusting the Viewing Angle .....	14
Installing the Video Card and Video Driver .....	15
Supported Video Display Modes and Refresh Rates .....	15
Configuring the Display Settings .....	15
Using the Standard Controls for the Video Card .....	15
Multimedia Features .....	16
Optional Card Reader Bracket .....	16
Supported MagStripe Readers .....	16
Connecting the Touch Monitor .....	17
Cable Management System .....	19
Testing the M150 FPD .....	20
Installing Touch Software .....	20
Calibrating the Touch Screen .....	21

<b>Chapter 3</b>	<b>Video Display Options</b>	
	Adjusting the M150 Video Display.....	23
	Auto Config .....	24
	Brightness .....	24
	Contrast.....	25
	Color .....	25
	Position .....	25
	Image .....	26
	Miscellaneous Menu .....	27
	Lock Out Feature .....	27
<b>Chapter 4</b>	<b>Maintenance and Troubleshooting</b>	
	Maintaining Your Touch Monitor.....	29
	Touch Screen Care and Cleaning .....	29
	Monitor Installation Problems.....	30
	Troubleshooting the Touch Screen.....	31
	Power Management.....	31
	M150 Regulatory Agency Approvals.....	31
	FCC Warning.....	32
	CE Conformity for Europe.....	32

# Overview

Welcome to the world of 3M Touch Systems — a world where using a computer is as simple as touching the screen. This guide describes how to set up your M150 Flat Panel Display (FPD) touch monitor.

This document assumes you have basic computer skills. You should know how to use the mouse and keyboard, choose commands from menus, open and run application programs, and save files.

3M Touch Systems, Inc. is committed to being a premier supplier in touch systems throughout the world. As a 3M Touch Systems, Inc. customer, you are aware that we have strong internal programs that meet or exceed environmental regulations of our customers and the regions in which we conduct business.

As such, our approach to the European Union Directives 2002/96/EC (WEEE) and 2002/95/EC (RoHS) (the directives) is being addressed in the same rigorous manner. To ensure compliance with the directives, we are pleased to provide this RoHS compliant product.



## Important Safety Information

Read and understand all safety information before using this product. Follow all instructions marked on the product and described in this document. Pay close attention to the following installation warnings and safety precautions.

### Intended Use

The M150 flat panel display (FPD) touch monitor was designed for touch input and tested to replace an existing monitor. These monitors are intended for indoor use only and are not designed for use in hazardous locations.

### Explanation of Signal Word Consequences

-  **DANGER:** Indicates a potentially hazardous situation, which, if not avoided, will result in death or serious injury and/or property damage.
-  **WARNING:** Indicates a potentially hazardous situation, which, if not avoided, could result in death or serious injury and/or property damage.
-  **CAUTION:** Indicates a potentially hazardous situation, which, if not avoided, may result in minor or moderate injury and/or property damage.
- CAUTION:** Indicates a potentially hazardous situation, which, if not avoided, may result in property damage.

**⚠ DANGER**

**To avoid the risk of fire and/or explosion which will result in serious injury or death:**  
Do not install or use this product in a hazardous location.

**⚠ WARNING**

**To avoid the risk of fire which could result in serious injury or death:**  
Do not remove the cover or back of the monitor.

**To avoid the risk of electric shock which could result in serious injury or death:**

- This device must be operated with the original power supply, part number: HJC, HASU05F or CHI, CH-1234.
- Do not use a damaged power supply.
- Do not use a power cord that is frayed or otherwise damaged.

**⚠ CAUTION**

**To avoid the risk of electric shock which may result in minor or moderate injury:**

- The socket-outlet should be installed near the equipment and should be easily accessible.
- Use a power cable that is properly grounded. Always use the appropriate AC cord certified for the individual country. Some examples are listed below:
 

USA	UL
Switzerland	SEV
Canada	CSA
Britain	BASE/BS
Germany	VDE
Japan	Electric Appliance Control Act
- Do not service the Flat Panel Display.
  - There are no user serviceable parts inside.
  - Refer all servicing to qualified service personnel.
  - The backlight inverter output is at high voltage.
- Do not use non-conforming replacement parts.
- Do not place wet or damp objects on the monitor.
- Do not expose the monitor to rain or other sources of water, steam, or moisture.
- Do not place foreign objects on the monitor or its cables.
- Do not remove the cover or back of the monitor.

**To avoid the risk of glass breakage which may result in minor or moderate injury:**

- Handle the monitor with care to avoid breaking the touch screen sensor. The display contains glass parts. Dropping the display may cause the glass parts to break.
- Do not place foreign objects on the monitor.

**To avoid the potentially hazardous situations associated with the use of isopropyl alcohol which may result in minor or moderate injury or property damage:**

Follow all instructions and recommendations in the manufacturer's Material Safety Data Sheet and product label.

**To avoid possible environmental contamination which may result in minor or moderate injury:**

Dispose of the flat panel display according to applicable governmental regulations.

**Explanation of Symbols**

**⚠** Attention: Read accompanying documentation

**Important Notes:**

- Plug power cord into appropriate power source.
- Plug power cord into a grounded receptacle.
- When unplugging power supply cord, pull on plug not cord.
- Do not connect or disconnect this product during an electrical storm.
- Install the display in a well-ventilated area. Always maintain adequate ventilation to protect the display from overheating and to ensure reliable and continued operation.
- Do not expose this display to heat. Passive heat may cause damage to the case and other parts.
- Do not install this display in areas where extreme vibrations may be generated. For example, nearby manufacturing equipment may produce strong vibrations. The vibrations may cause the display to exhibit picture discoloration or poor video quality.
- Ensure that metal does not contact the touch screen.
- To avoid ergonomic concerns:  
Do not install the monitor in a manner or location with awkward accessibility.  
Extended use may result in muscle, tendon, or fixed posture strains. It is recommended you take periodic breaks from continuous use.

**Service and Repair Indicators**

Do not attempt to service this unit yourself. Removing the display cover may expose you to dangerous voltage or other risks and will void the warranty.

**WARNING**

**To avoid the risk of fire which could result in serious injury or death:**

Do not remove the cover or back of the monitor.

**CAUTION**

**To avoid the risk of electric shock which may result in minor or moderate injury:**

- Do not service the monitor.
- There are no user serviceable parts inside.
- Refer all servicing to qualified service personnel.
- Do not remove the cover or back of the monitor.

Unplug the display from the power outlet and refer servicing to qualified service personnel in the event that:

- Liquid is spilled into the product or the product is exposed to rain or water.
- The product does not operate properly when operating instructions are followed.
- The product has been dropped or the case has been damaged.
- The product shows a distinct change in performance, indicating a need for service.
- The power cable or plug is damaged or frayed.

## 3M Touch Systems Support Services

3M Touch Systems provides extensive support services through our website and technical support organization. Visit the 3M Touch Systems website at <http://www.3mtouch.com/>, where you can download touch screen software and drivers, obtain regularly updated technical documentation on 3M Touch Systems products, and learn more about our company.

Whenever you contact Technical Support, please provide the following information:

- Part number and serial number from your monitor
- Current driver version
- Operating system used
- Information on additional peripherals

Technical Support is available Monday through Friday 8 a.m. to 8 p.m. US Eastern Standard Time – 9 a.m. to 5 p.m. throughout Europe.

You can contact 3M Touch Systems Technical Support (US only -- Eastern Standard Time) by calling the hot line, sending an email, or sending a fax.

- Technical Support Hot Line: 978-659-9200
- Technical Support Fax: 978-659-9400
- Toll Free: 1-866-407-6666 (Option 3)
- Email: US-TS-techsupport@mmm.com

## 3M Touch Systems Worldwide Offices

All offices can be reached through the website: <http://www.3Mtouch.com/>.

## CHAPTER 1

# Introduction to Flat Panel Displays

The 3M Touch Systems product line of Flat Panel Display (FPD) touch monitors offers the M150 monitor for desktop and countertop applications with built-in multimedia options. The monitor is available with 3M Touch System's ClearTek® capacitive touch screen. Capacitive is the touch screen of choice for public access applications requiring high levels of durability and reliable performance 24 hours a day, 7 days a week.

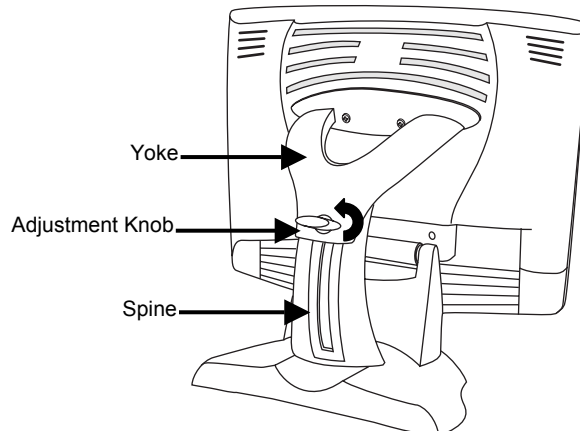

The newly redesigned M150 monitor features an innovative design adjustable to approximately 60° off the vertical to accommodate different counter and user heights, a positive locking mechanism, a weighted base for additional stability, a touch screen interface, several mounting options, and built-in cable management.

The M150 monitor also features a space saving design, high resolution, low radiation, and low power consumption. These qualities make the M150 FPD touch monitor ideal for applications that require superior color, resolution, and clarity.

The M150 FPD is available in a 15" diagonal screen size using active-matrix thin-film transistor (AM-TFT) liquid crystal display technology. The M150 monitor supports a full-screen resolution of 1024 x 768.

**Note:** The M150 FPD has a power LED as well as four buttons for using the on-screen menu and adjusting the video display. Refer to Chapter 3 for more information on these controls.

---

## **Native Video Resolution on a Flat Panel Display**

Flat panel displays, unlike CRTs, are optimized to run at one resolution. A flat panel display has discrete points that determine the exact location of a pixel. Each flat panel display has an exact number of pixels associated with it. There is a one-to-one mapping between the number of pixels and the video resolution.

A flat panel display should be used at the resolution dictated by the number of pixels on the panel for optimum performance. For example, the M150 monitor has 1024 pixels across the screen and 768 lines of pixels down the screen and can accurately display this resolution at full screen.

## **Options for Using Other Video Resolutions**

The M150 monitor supports all standard resolutions up to their respective native resolution for monitor setup. Many video cards initially display a screen image at the SVGA or VGA resolution. By supporting these resolutions, the monitor can display the desktop controls that let you change to the optimal resolution of 1024 x 768.

## CHAPTER 2

# Setting Up Your M150 FPD Monitor

This chapter describes how to set up and integrate your 3M Touch Systems M150 FPD monitor into a touch application system. You need to complete the following tasks:

- Unpack the components
- Connect the video, touch screen, and power cables
- Power on the monitor and test your setup
- Install the touch screen software
- Calibrate the touch screen

## System Requirements

The M150 flat panel touch monitor requires a personal computer (PC). This touch monitor will not work with Apple Macintosh computers.

The requirements for your PC are as follows:

- Your PC must have an available RS-232 serial communication (COM) port or USB port. You connect the touch screen to this port.
- Your PC must have a video card and video driver already installed for the monitor. If you need to install a video card or a video driver, refer to your computer documentation for instructions.
- Your PC must have a unique interrupt request (IRQ) available to the touch screen COM port. The touch screen cannot share an IRQ with another device.

When choosing your workspace, select a sturdy, level surface. Also, make sure you can easily access the back of the touch monitor and the computer. Easy access helps ensure a smooth setup of the touch monitor.

---

**Note:** Before setting up your M150 FPD, refer to the Important Safety Information section at the beginning of this document.

---

## Unpacking Your Touch Monitor

Carefully unpack the carton and inspect the contents. Your M150 monitor includes the following cables as well as a touch software CD.



15-pin video cable



9-pin RS-232 serial communication cable (if applicable)



AC/DC power supply (12V DC output)



AC power cable



USB Cable (if applicable)



Multimedia audio cables

## Arm Mounting Option

The unit has a 75 mm VESA mounting pattern on the back to allow for arm mount capability. Follow the manufacturer's instructions included with the mounting device to properly attach your monitor.

In order to arm-mount the M150 FPD, you will need to remove the monitor face from the stand and yoke.

### Figure 1 Disassembling the Yoke & Base for Arm Mounting

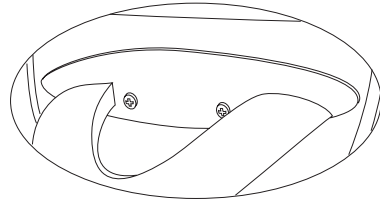

Step 1 -- Unlock the yoke. With the unit laying face down safely and securely on a nonabrasive surface, remove the two screws connecting the top of the yoke. Lift yoke and pull down to disengage tabs to remove.

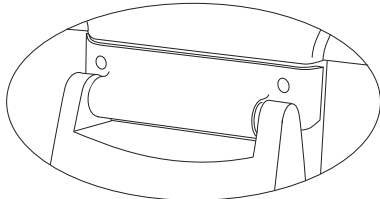

Step 2 -- Remove the bottom two screws holding the hinge cover in place. Remove the small hinge cover.

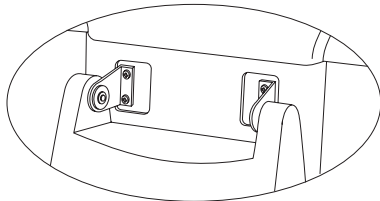

Step 3 -- Remove the inner four screws holding the base to the FPD and gently remove the base.

### Countertop Base Mounting Option

Keyhole slots in the bottom of the base plate enable you to secure the unit to a desktop or countertop. Use standard screws in the desktop or countertop and then slide the base plate on for a secure fit.

**Note:** A full size template has been included in the back of this manual for your convenience. Simply tear out the template and drill directly through the holes indicated to secure your monitor to any surface.

### Figure 2 Keyhole Mounting Slots

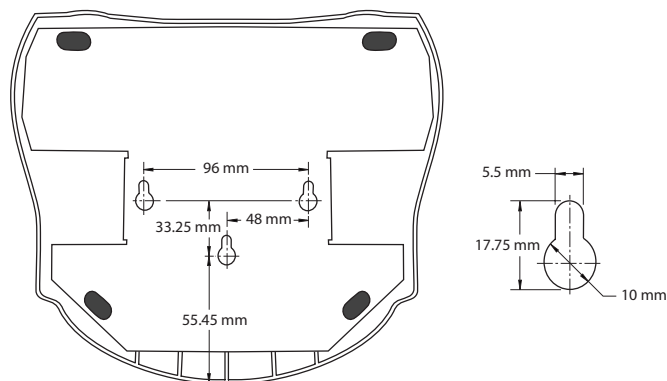

## Access to the Video Controls

The controls for adjusting the video display are located on the front of the M150 FPD monitor. These buttons let you display the on-screen menu and adjust the phase, image position, contrast, and brightness. Make sure you have unobstructed access to the video controls once the M150 monitor is installed.

**Figure 3 Video Display Controls**

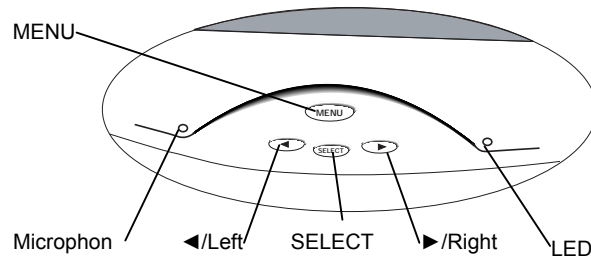

## Adjusting the Viewing Angle

The yoke and spine were designed with touch stability in mind. This innovative design keeps the monitor face stable during touch. The unit can be adjusted to any locked position from 0 up to 60 degrees from vertical. This allows for users of different heights to view the monitor at the angle that best suits them with no degradation in touch stability.

Turn the positive locking mechanism adjustment knob 1/4 turn (horizontal to vertical) to loosen. Adjust the M150 FPD by pushing on the top front of the monitor until the screen is at the best viewing angle for you. Then turn the adjustment knob a 1/4 turn back to lock in place. To raise the monitor back to vertical, unlock the adjustment knob, lift slightly on the adjustment knob and pull up.

**Figure 4 Viewing Angle Adjustable from 0 up to 60 degrees**

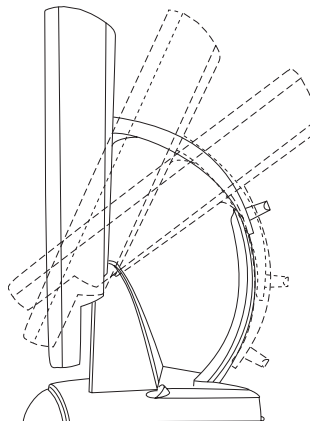

---

**Note:** When the adjustment knob is horizontal it is locked; when it is in the vertical position it is unlocked.

---

Always maintain adequate ventilation to protect the display from overheating and to ensure reliable and continued operation.

## Installing the Video Card and Video Driver

Before you can connect your touch monitor, make sure your computer has a video card and driver already installed for the monitor. The video driver is supplied by the video card manufacturer and may be found on the disks that came with your computer. If you need information on installing a video card or video driver, refer to your computer documentation for instructions.

### Supported Video Display Modes and Refresh Rates

Your video card should support one of the display modes specified in Table 1. If you select an unsupported video mode, the monitor may stop working or display unsatisfactory picture quality.

**Table 1. Applicable Display Mode and Refresh Rate**

Display Mode	Refresh Rate
VGA (640 x 480)	60
	72
	75
US Text (720 x 400)	70
SVGA (800 x 600)	56 Hz
	60
	72
XGA (1024 x 768)	75
	60
	70
	75

## Configuring the Display Settings

After you connect your M150 FPD and turn on your computer, you may need to configure one or more of these display settings. The ideal settings for this monitor are as follows:

- Display mode (also called desktop area or video resolution) 1024 x 768
- Refresh rate (also called vertical scan rate or vertical sync) 60 Hz
- Color depth (also called color palette or number of colors) at least 16-bit (high color)

### Using the Standard Controls for the Video Card

In addition to the standard controls on the monitor, each video card has several controls that let you adjust the display settings. The software and driver for each video card is unique. In most cases, you adjust these settings by using a program or utility provided by the manufacturer of the video card.

For example, you can use the Windows Display Properties control panel to adjust the desktop area (resolution), color depth, and refresh rate. Whenever you change these settings or calibrate the touch screen, the image size, position, or shape may change. This behavior is normal. You can readjust the image using the monitor controls described in Chapter 3 of this guide.

For more information on adjusting the desktop area (resolution), color depth, or refresh rate, refer to your video card documentation.

## Multimedia Features

The M150 FPD monitor comes with multimedia features built-in. It has a microphone and speakers built into the back of the display bezel and includes multimedia cables. These cables can be connected from either the rear of the monitor or in front -- two separate sets of jacks are included.

**Figure 5 Multimedia Cables**



## Optional Card Reader Bracket

The M150 FPD monitor is available with an optional card reader bracket (and (2) M3 screws) that supports IDTech and MagTek brand electronic card readers. The black version is part number 5013923 and the beige version is 5103924. The M150 has been designed with slots on either side of the bezel to accommodate this card reader bracket. Simply slide the bracket into the appropriate holes and pull down slightly to lock in place. Refer to the illustration below for wiring suggestions. Note that 3M Touch Systems does not supply these card readers.

## Supported MagStripe Readers

At the time of publication, the following “mini” magnetic card readers have been tested to fit the 3M Touch Systems optional card reader bracket. Consult your card reader sales representative for model numbers not listed here.

ID Tech		MagTek
all MiniMag™ readers		all "mini" sized readers
IDT 3331-02U	IDT 3321-33	2180201
IDT 3331-12U	IDT 3321-33PP	2180202

IDT 3331-23U	IDT 3331-02	2180203
IDT 3331-33U	IDT 3331-12	2180204
IDT 3321-02	IDT 3331-23	2180205
IDT 3321-02PP	IDT 3331-33	2180206
IDT 3321-12	IDT3301-02	21040103
IDT 3321-12PP	IDT3301-12	21040104
IDT 3321-23	IDT3301-23	
IDT 3321-23PP	IDT3301-33	

**Figure 6 Card Reader Mounting and Cable Management**

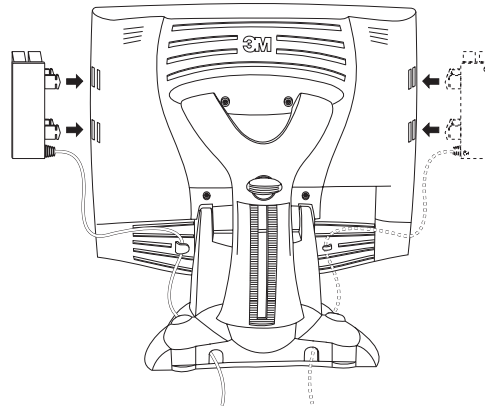

## Connecting the Touch Monitor

**⚠ CAUTION**

You are cautioned that any change or modification to the equipment not expressly approved by the party responsible for compliance could void your authority to operate such equipment.

To connect the M150 FPD monitor:

1. Turn off your computer. You should always turn off the computer before connecting or disconnecting any device.
2. Connect one end of the video cable to the video connector on the FPD. Connect the other end to the video card in your computer.
3. Connect one end of the touch screen cable (either serial or USB) to the FPD. Connect the other end to an available port on the back of your computer. If you are using a USB connection, make sure you have installed the Touch Software drivers prior to connecting the touch screen cable.
4. Plug the AC/DC power supply into the M150 FPD. Be sure to use the power supply included with the monitor.

**Figure 7 Identifying Your Monitor Connections**

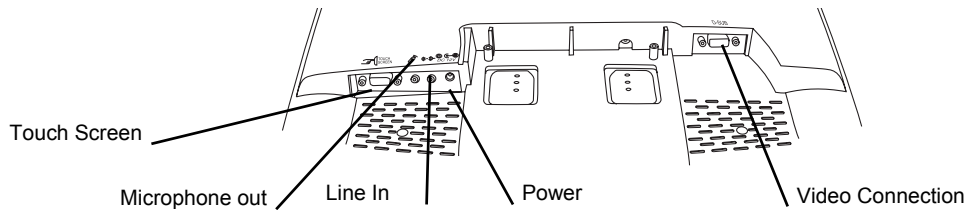

**⚠ WARNING**

**To avoid the risk of electric shock which could result in serious injury or death:**

- This device must be operated with the original power supply, part number: HJC, HASU05F or CHI, CH-1234.

**⚠ CAUTION**

**To avoid the risk of electric shock which may result in minor or moderate injury:**

- The socket-outlet should be installed near the equipment and should be easily accessible.
- Use a power cable that is properly grounded. Always use the appropriate AC cord certified for the individual country. Some examples are listed below:

USA	UL
Switzerland	SEV
Canada	CSA
Britain	BASE/BS
Germany	VDE
Japan	Electric Appliance Control Act

5. Connect the power cable to the AC/DC supply. Connect the other end to the appropriate AC outlet.

### Figure 8 Connecting the M150 Cables to your Computer

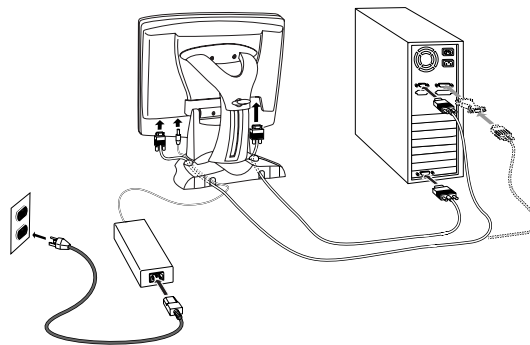

You should be sure all cable connections are secure -- tighten all cable screws. Shaking and vibration may dislodge cables that are improperly connected.

Route all wiring and cabling away from heat sources and sharp metal edges to avoid damage. Also, keep the touch screen cable away from sources of electromagnetic and radio frequency interference.

**⚠ WARNING**

To avoid the risk of electric shock which could result in serious injury or death:

- Do not use a damaged power supply.
- Do not use a power cord that is frayed or otherwise damaged.

## Cable Management System

**Figure 9 Removing the Cable Management Cover**

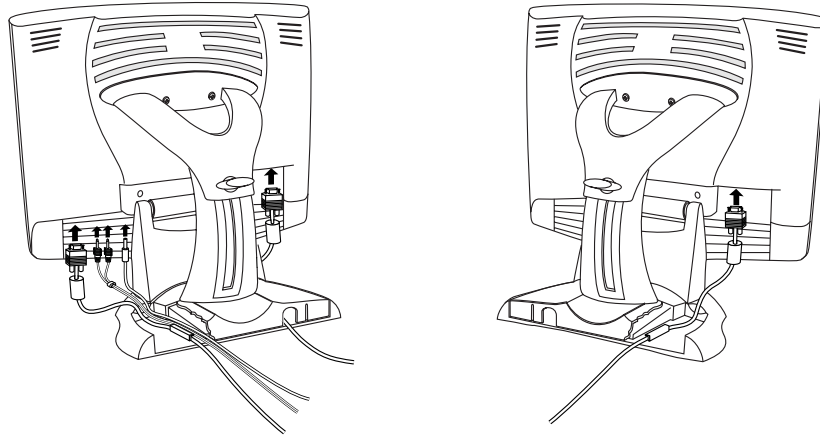

Once you have connected your M150 FPD monitor to your computer, you should take advantage of the cable management system designed into the base of the M150 FPD monitor as shown above.

In order to properly route all cables through the cable management system, the cover on the base unit must be removed. To remove this cover:

1. Push in and lift up on each of the two tabs located on the left and right sides of the cover. This action will release the cover tabs from the base.

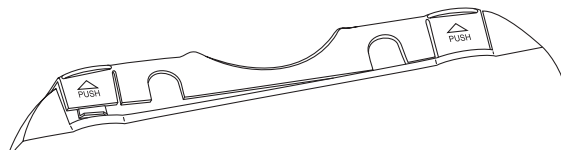

2. Slide the cover back towards you to remove.

## Testing the M150 FPD

---

**Note:** The M150 FPD has a power status light located on the front of the bezel.

---

After connection, turn on the power switch located at the bottom of the front bezel. Before you test your touch monitor, make sure all cables are connected properly and routed through the cable management system. Be sure to tighten all cable screws.

To test that the monitor is working properly:

1. Turn on your computer.
2. Make sure the video image is displayed. If it is not, turn on your monitor.
3. Make sure the video image is centered within the screen area. Use the monitor controls to adjust the image, if necessary.

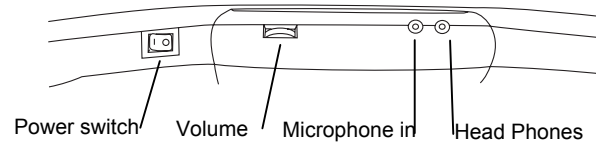

Perform an Auto Config first, then if you wish you can adjust the horizontal and vertical position, contrast, and brightness to better suit your video card and your personal preference. Refer to Chapter 3 for more information on using the on-screen menu to adjust the video display.

## Installing Touch Software

Touch Software includes the touch screen driver and control panel that enables your touch screen to work with your computer. When you install the CD included with your monitor, Touch Software will automatically load the correct driver for your system. 3M Touch Systems currently supports touch screen drivers for the following PC operating systems:

- Windows XP (serial and USB)
- Windows 2000 (serial and USB)
- Windows NT 4.0 (serial only)
- Windows 9x (serial and USB (Windows 98 only))
- Windows Me (serial and USB)

These drivers and relevant technical documentation, can be found on the latest 3M Touch Solutions CD (31197) and are also available for download from our website at [www.3Mtouch.com](http://www.3Mtouch.com). After the software is installed, restart your computer to load and activate the touch screen driver. To complete the setup of your touch monitor, make sure you calibrate the touch screen.

## Calibrating the Touch Screen

After you connect your touch monitor and install Touch Software, you must calibrate the touch screen. *Calibration* serves two purposes:

- Sets the active area of the touch screen
- Aligns the touch screen's active area to the underlying video

To calibrate the touch screen, open the touch screen control panel and select Calibrate. Follow the directions displayed on the screen. For more information on calibration, refer to the online help or the user documentation.



## CHAPTER 3

# Video Display Options

This chapter provides guidelines for adjusting the video display and using the monitor controls to adjust the image to your liking. Before you make any adjustments:

- Be sure to adjust the controls in your normal lighting conditions.
- Display a test image or pattern whenever you adjust the video.

### Adjusting the M150 Video Display

Your M150 FPD monitor has four controls to adjust the video display.

- MENU – Shows or hides the menu.
- SELECT -- Highlights the current menu option or saves the current setting. Press ► or ◀ to change the value.
- ◀/Left -- Enables you to scroll backwards through items on the menu -- decrease the value of selected option or move to the previous menu item.
- ►/Right -- Enables you to scroll forward through items on the menu -- increase the value of selected option or move to the next menu item.

If you do not press the Menu, Select, or ◀/left or ►/right adjust buttons for 45 seconds, the monitor adjustment program times out and hides the menu options. You can press the Menu button at any time to display the options again.

Pressing MENU will pull up the On Screen Display (OSD) menu, as shown below.

**Figure 10 M150 Main Menu Options**

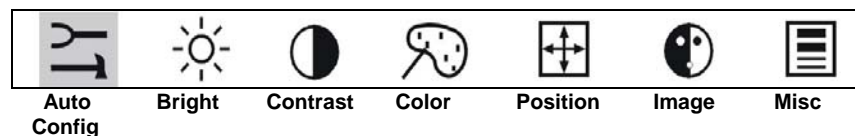

## Auto Config

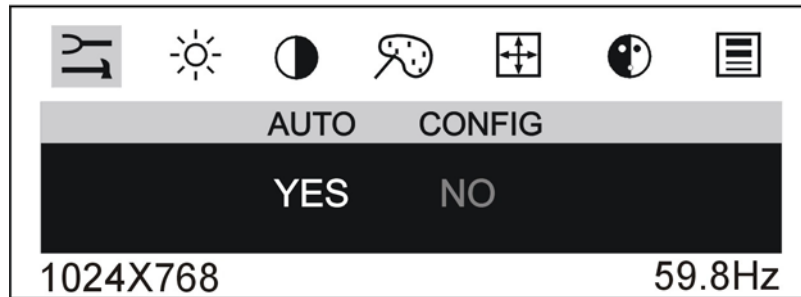

To perform an Auto Config, press the ◀/left arrow key once then press SELECT. The Main Menu item Auto Config is used to adjust the configuration of the phase clock vertical and horizontal position automatically. A confirmation box is displayed to confirm the user selection. The default selection in the box is NO and is highlighted by a red bar.

If the Select key is pressed, the main menu is redisplayed and nothing is changed. When “Yes” is selected an automatic configuration is started. After the process is completed successfully, a confirmation box “Does this image look correct?” is displayed. If image is correct, select “Yes” to exit confirmation box. If image isn’t correct, select “No” to go to PHASE item adjustment and adjust the phase manually to the best image quality.

If you change your display to Windows shut down mode, this noise will be more visible, and easier to eliminate. Click on the "Start" button and then click Shut Down. This will bring you to the Windows shutdown mode. After finishing phase adjustment, click on the "Cancel" to return to your original Windows display.

## Brightness



Selecting the Brightness option will allow you to adjust the brightness of the display. Adjust the brightness using the ◀/left and ▶/right arrow buttons, and press SELECT to confirm the new setting.

### Contrast

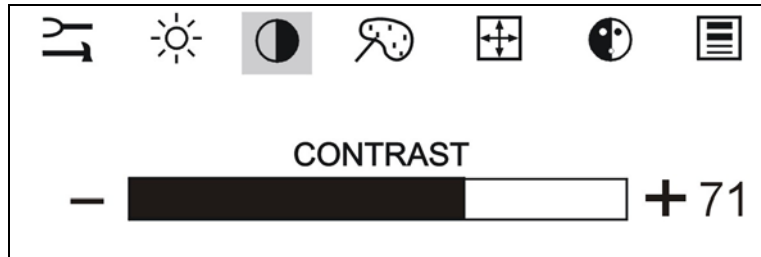

Selecting the Contrast option will allow you to adjust the contrast of the display. Adjust the contrast using the ◀/left and ▶/right arrow buttons, and press SELECT to confirm the new setting.

### Color

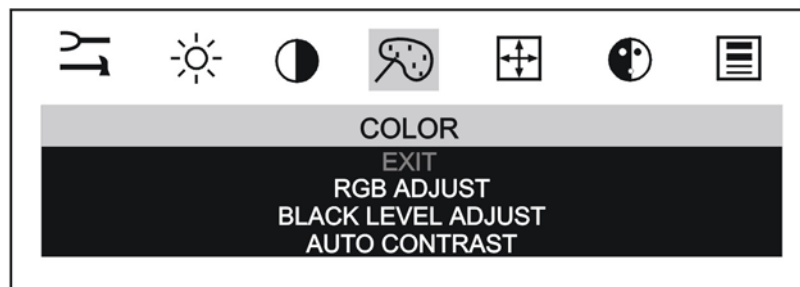

When you choose the Color option from the OSD, this will bring up a sub-menu that allows you to adjust the RGB or Black Level color balance for your display. Use the ◀/left and ▶/right arrow buttons to scroll through the color menu.

You can also use the Auto Contrast feature to automatically adjust the color and contrast of your display.

By adjusting a single color, you can make the picture look warmer (biased towards red) or cooler (biased towards blue). Adjusting all three levels will make colors appear more or less striking.

### Position

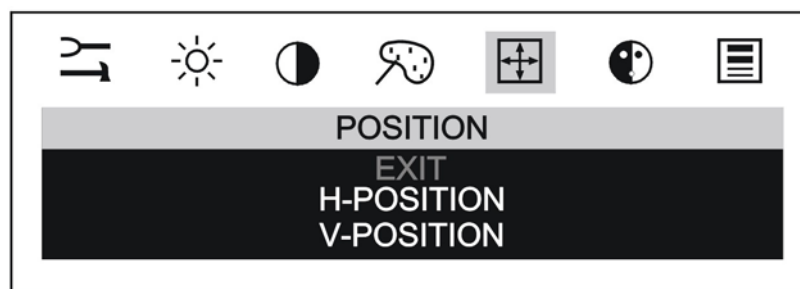

You can use the Position option to center the image on the display manually. Use the ◀/left and ▶/right arrow buttons to scroll through the position menu.

- H-Position is used to adjust the horizontal image position manually.
- V-Position is used to adjust the vertical image position manually.

## Image

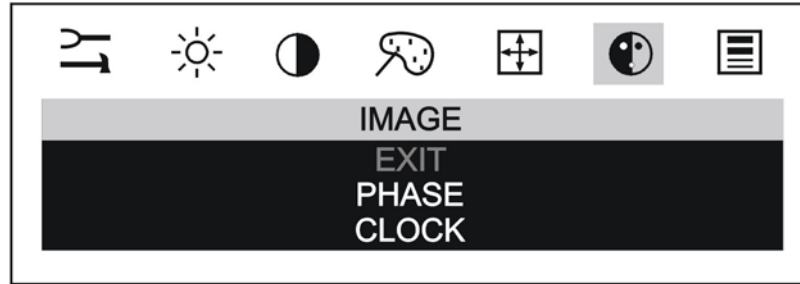

Use the ◀/left and ▶/right arrow buttons to scroll through the image menu.

**Phase:** If the phase of your monitor is not fine-tuned, you may observe unstable horizontal noise lines and cross-talk stretching from the edge of small windows on your display.

If you change your display to Windows shut down mode, this noise will be more visible, and easier to eliminate. Click on the "Start" button at the bottom right side, and then click Shut Down. This will bring you to the Windows shutdown mode. After finishing phase adjustment, click on the "Cancel" to return to your original Windows display.

**Clock:** If the clock setting of your image is not fine-tuned, you may observe periodic vertical bars of video noise on your image. These bars of noise are usually adjusted out when an Auto Configuration is performed. If the bars of noise are still present, this setting can be adjusted manually.

Adjust this setting so that either the vertical bars of noise are replaced by an even amount of noise across the whole screen, or the noise disappears completely.

If you do an Auto Config, the monitor will try to find the best Clock/Phase setting. If you are not satisfied with the auto adjustment, fine-tune the phase manually as described above.

## Miscellaneous Menu

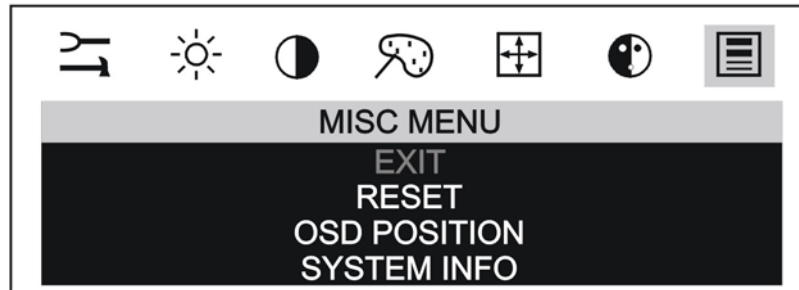

The Miscellaneous Menu contains three options: Reset, OSD Position, and System info.

- **Reset** is used to reload all factory default parameters.
- **OSD position** is used to setup the OSD menu position – horizontal and vertical position is adjusted separately. Each position item will bring up the slider window – the maximum value of the sliders are based on the size of the OSD menu.
- **System Info** is used to provide detailed information regarding the current input resolution/frequencies and firmware version.

---

**Note:** The OSD will timeout after 45 seconds of inactivity and will not save any new settings.

---

## Lock Out Feature

Once you have fine-tuned your display, you may want to restrict users from inadvertently making changes. In order to do this, follow this simple procedure. Repeat the procedure to restore access.

1. Press SELECT and then press the ◀/left arrow key. Hold both keys for 10 seconds. DO NOT RELEASE.
2. Then press the ▶/right arrow key and hold all three keys together for an additional 10 seconds.



## CHAPTER 4

# Maintenance and Troubleshooting

If you have a problem setting up or using your monitor, you may be able to solve it yourself. Before calling 3M Touch Systems, try the suggested actions that are appropriate to the problems you are experiencing with the monitor. You may also want to consult your video card user's manual for additional troubleshooting advice.

## Maintaining Your Touch Monitor

To maintain your display and keep your monitor operating at peak performance:

- Keep your monitor and screen clean.
- Adjust the monitor video controls. Refer to Chapter 3 for more information.
- Do not install the display in a place where ventilation may be hindered. Always maintain adequate ventilation to protect the display from overheating and to ensure reliable and continued operation.

## Touch Screen Care and Cleaning

The touch screen requires very little maintenance. 3M Touch Systems recommends that you periodically clean the glass touch screen surface.

Typically, an isopropyl alcohol and water solution ratio of 50:50 is the best cleaning agent for your touch screen. You can also use straight isopropyl alcohol. In addition, 3M Screen and Keyboard Cleaner CL680 has been tested and approved for this use.

### CAUTION

To avoid the potentially hazardous situations associated with the use of alcohol or other solvents which may result in minor or moderate injury or property damage:

- Follow all instructions and recommendations in the manufacturer's Material Safety Data Sheet and product label.
- Be sure to follow solvent manufacturer's precautions and directions for use when using any solvents
- It is important to avoid using any caustic chemicals on the touch screen. Do not use any vinegar-based solutions.

- Apply the cleaner with a soft, lint-free cloth. Avoid using gritty cloths.
- Always dampen the cloth and then clean the screen. Be sure to spray the cleaning liquid onto the cloth, not the screen, so that drips do not seep inside the display or stain the bezel.
- Always handle the touch screen with care. Do not pull on or stress cables.

## Monitor Installation Problems

Problem	Possible Causes and Solutions
No image displayed (blank screen)	<p><b>Is the monitor receiving power?</b></p> <ul style="list-style-type: none"> <li>• Check that the computer's power cable is connected properly and securely in a grounded electrical outlet.</li> <li>• Check that the AC/DC power supply is firmly plugged into the monitor.</li> <li>• Check that the green light appears on the bezel indicating the monitor is powered on.</li> <li>• Check that the AC/DC power supply cable is connected properly and securely to an electrical outlet. Check that the LED is showing green on the AC/DC power supply.</li> <li>• Try using another power cable.</li> <li>• Try using another electrical outlet.</li> </ul> <p><b>Is the monitor receiving a valid video signal from the PC?</b></p> <ul style="list-style-type: none"> <li>• Check that the computer is powered on.</li> <li>• Check that the video cable is connected properly and securely to the monitor and the computer.</li> <li>• Check that no pins are bent in the video cable connector.</li> <li>• Check that the video card is firmly seated in the card slot in your computer.</li> <li>• Check that the video input from the video card falls within the refresh rate of the display. Refer to <b>Table 1</b> for details.</li> <li>• Check that your computer is using a supported display mode. Refer to <b>Table 1</b> for details.</li> </ul> <p><b>Is the monitor in Power Management mode?</b></p> <ul style="list-style-type: none"> <li>• Touch the screen, press any key on the keyboard, or move the mouse to restore operation.</li> </ul> <p><b>Are the brightness and contrast settings too low?</b></p> <ul style="list-style-type: none"> <li>• Use the monitor controls to adjust these values.</li> </ul>
Abnormal image	<ul style="list-style-type: none"> <li>• Check that the video input from the video card falls within the refresh rate of the display. Refer to <b>Table 1</b> for details.</li> <li>• Check that the video cable is connected properly and securely to the monitor and the computer.</li> </ul>
Colors of image are abnormal	<ul style="list-style-type: none"> <li>• Check that the video cable is connected properly and securely to the monitor and the computer.</li> <li>• Check that no pins are bent in the video cable connector.</li> </ul>
Disturbances on the screen	<ul style="list-style-type: none"> <li>• The video display adjustments are incorrect. Refer to Chapter 3 for adjusting procedures.</li> </ul>

## Troubleshooting the Touch Screen

If you are experiencing problems with the touch screen, check the following list of common installation errors.

**Table 2. Common Touch Screen Installation Issues**

Common Installation Issues	Possible Solutions
Touch screen does not respond to touch	<ul style="list-style-type: none"> <li>• Review the installation procedures. Are all cables connected properly?</li> <li>• After you installed touch software, did you restart your PC to activate the touch screen driver?</li> <li>• Are the communication settings correct? Is the touch screen trying to use the COM port or IRQ of another device (for example, a mouse)? If so, a hardware device conflict will result and the touch screen will not work.</li> </ul>
Touch screen is not accurate	<ul style="list-style-type: none"> <li>• Calibrate the touch screen for the current video resolution and operating system.</li> </ul>
Cursor does not follow finger movement or does not reach the edges of the screen	<ul style="list-style-type: none"> <li>• Calibrate the touch screen for the current video resolution and operating system.</li> </ul>
Cursor is not located directly underneath your finger	<ul style="list-style-type: none"> <li>• Open the touch screen control panel and make sure all cursor offsets (vertical, edge/horizontal) are turned off.</li> <li>• Calibrate the touch screen for the current video resolution and operating system.</li> </ul>
Cursor is extremely jittery or erratic	<ul style="list-style-type: none"> <li>• Stabilize the cursor by adjusting the operating frequency of the touch screen controller using the touch screen control panel.</li> </ul>

## Power Management

The M150 monitor conforms to the Video Electronics Standards Association (VESA) Display Power Management Signaling (DPMS) standard. To benefit from power management, the monitor must be used in conjunction with a computer and video card that implements the VESA DPMS standard.

The PC automatically invokes the power management feature if you do not use the touch screen, mouse, or keyboard for a user-defined period of time. To restore the video image, simply touch the screen, press a key, or move the mouse.

## M150 Regulatory Agency Approvals

Your product complies with the following regulatory standards:

- FCC-B
- CE
- UL/cUL
- VCCI
- CCC
- C-tick
- RoHS/WEEE directives

This equipment has been tested and found to comply within limits for a Class B digital device, pursuant to Part 15 of the FCC rules. These limits are designed to provide reasonable protection against harmful interference in residential installations. This equipment generates, uses and can radiate radio frequency energy, and if not installed and used in accordance with the instructions, may cause harmful interference to radio communications. However, there is no guarantee that interference will not occur in a particular installation. If this equipment does cause interference to radio or television equipment reception, which can be determined by turning the equipment off and on, the user is encouraged to try to correct the interference by one or more of the following measures:

- Reorient or relocate the receiving antenna.
- Move the equipment away from the receiver.
- Consult the dealer or an experienced radio/television technician for additional suggestions.

 <b>CAUTION</b>
You are cautioned that any change or modification to the equipment not expressly approved by the party responsible for compliance could void your authority to operate such equipment.

This Class B digital apparatus meets all requirements of the Canadian Interference-Causing Equipment Regulations.

Cet appareil numérique de la classe B respecte toutes les exigences du Règlement sur le matériel brouilleur du Canada.

This device complies with Part 15 of the FCC rules: Operation is subject to the following two conditions: (1) This device may not cause harmful interference, and (2) this device must accept any interference received, including interference that may cause undesired operation.

### **FCC Warning**

To assure continued FCC compliance, the user must use grounded power supply cord and the provided shielded video interface cable with bonded ferrite cores. If a BNC cable is going to be used, use only a shielded BNC(5) cable. Also, any unauthorized changes or modifications not expressly approved by the party responsible for compliance could void the user's authority to operate this device.

3M Touch Systems is not responsible for any radio or television interference caused by using other than recommended cables and connectors or by unauthorized changes or modifications to this equipment.

## **CE Conformity for Europe**

The device complies with the requirements of the ECC directive 89/336/EEC as amended by 92/31/EEC and 93/68/EEC Art.5 with regard to "Electromagnetic compatibility", and 73/23/EEC as amended by 93/68/EEC Art.13 with regard to "Safety".

Rear Edge of  
Base Not Shown

# M150 Base Plate Mounting Template

(Drawn actual size)

Cut Line

3M Touch Systems Proprietary Information

Place this template on mounting surface and drill three holes as shown for mounting screws.  
The screw heads must be smaller than 0.39" (10 mm) and larger than 0.21" (5.5 mm).  
Adjust height of screw heads to securely lock monitor in place. This height is about 0.23" (6 mm).

Drill 3 Mounting Holes

0.39" (10 mm)

0.21" (5.5 mm)

3M Touch Systems, Inc. Proprietary Information

Front Edge of Base

